

INFORMATION

Technik

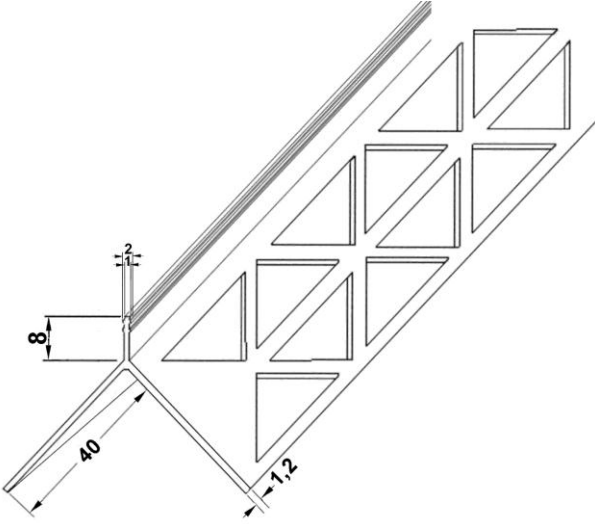

PRODUCT DATA SHEET

<p>Product group: 1185</p> 	<p>DESCRIPTION REF. NO.: 37408</p> <p>Y – CORNER BEAD FOR EXTERIOR RENDERING</p> <p>FOR PLASTER THICKNESS: ≥ 8 mm</p>
<p>MATERIAL STANDARD THICKNESS STANDARD FOR MEASUREMENTS COLOUR LENGTH OF PROFILES PACKING REMARKS</p>	<p>PVC – U - Hi DIN EN ISO 1163-1 1,2 mm DIN 16941 PVC NOSE WHITE N°.10, WING VARIABLE 250, 300 cm \pm 1 cm 20 LENGTHS / BOX</p>
<p>P R O T E K T O R W E R K Florenz Maisch GmbH & Co. KG Viktoriastr. 58 • D-76571 Gaggenau</p>	<p>Tel. 07225/977-0 Fax 07225/977-111 mailto:info@protektor.com http://www.protektor.com</p> <p>Modified 09/2012 Edition 08/2006</p>

The present data sheet corresponds to the actual stage of development of our products and ceases to be valid with a new edition. Make sure to use the latest edition of this information. Guarantee and liability are subject to our general terms and conditions of business. Please observe the guidelines for application, installation and storage. No liability assumed.